

LV2000

revision 1.4

Low Voltage Power Supply Retrofit Kit for
Wells-Gardner Color XY Monitor, model 19K6100

Kit Assembly Instructions



! WARNING !

To successfully assemble this kit requires that you have good soldering skills, and are able to identify the electronic components included in this kit.

Arcade games are rugged equipment, but anytime you start messing around with something (particularly something electronic) you accept a certain amount of risk that you may break something.

Failure to follow the instructions herein may cause serious damage to your monitor, LV2000 circuit, or both.

If the assembly of this kit looks to be beyond your confidence, please get someone experienced to assemble and install it for you.

Before starting anything, please read this document entirely and make sure that the instructions are clear to you.

CREDITS AND THANKS

Designing this retrofit kit was only one part of what goes in to making it available. There is these docs, organizing parts orders and packaging them for shipping

I want to thank the people who helped critique my design and motivate me to actually produce this thing. This includes all the folks on vectorlist, especially those who took an interest in my design.

I want to thank Jeff Hendrix for helping put together the parts orders, being the guinea pig for the prototype testing, and helping write these instructions.

INTRODUCTION

This kit contains an LV2000 printed circuit board and the parts necessary for board completion. The LV2000 kit, when installed, will eliminate almost all the original components of the low voltage power section of the Wells-Gardner deflection board. The only components of the original low voltage circuit that will remain are the four rectifier diodes (D100-D103), the large filter capacitors (C100, C101), and the two chassis mounted power transistors.

This kit will fix problems with your deflection board or monitor that are associated with the low voltage section.

The circuit consists of the LM317 positive and LM337 negative voltage regulator, and necessary support components. The voltage regulators have built in current limit, thermal overload protection and safe area protection. This protection circuitry internal to the ICs are what make the LV2000 practically indestructible. Once the LV2000 is installed and functioning, you should never have to replace the low voltage power section of your Wells-Gardner deflection board again.

GETTING STARTED

To assemble the LV2000 kit you will need the following tools at your disposal:

- A good soldering iron. One that has a good, clean, fine tip. The “pencil” type soldering irons are the only type you should use, do not use a “pistol” type soldering gun.
- Some rosin flux solder. 60/40 or 63/37 solder will work.
- Wire cutters.
- Patience, attention to detail, and the willingness to do a good job!
- Optionally, some de-soldering wick or a de-soldering pump.

Solder one component at a time to avoid making mistakes. Touch iron to the component lead and the PCB pad, then let solder flow from the hot component lead on to the pad. Try not to keep hot iron on component leads for more than 10 to 15 seconds. A hot, clean iron tip is important. **Keep soldering iron tip clean** by wiping it **frequently** on a wet sponge or wash cloth. Trim the leads as you go along.

When you have soldered all the components to the PCB, use a toothbrush with a little warm water and mild detergent to clean the flux off the bottom of the PCB. Make sure the PCB is dry before proceeding with the installation.

If you need further instruction on soldering techniques, there is a good soldering primer at <http://www.diac.com/~jeffh/lv2000/solder.html>

ASSEMBLING THE LV2000

First make sure that you have all the parts needed to complete the LV2000.

You should have one LV2000 bare PCB and the following components. *(these parts are included in the bag-0-parts)*
 (The *Designator* tells you the part's location on the board.)

Used	Part Type	Designators	Mouser Part No.
2	0.47uF 50V tantalum capacitor	C1 C2	581-0.47M50V
2	10uF 25V tantalum capacitor	C3 C4	581-10M25V
2	1uF 35V tantalum capacitor	C5 C6	581-1.0K35V
2	240 ohm resistor	R1 R2	29SJ250-240
2	4.3k ohm resistor	R3 R4	29SJ250-4.3k
2	4.7k ohm resistor	R5 R6	29SJ250-4.7k
2	1k potentiometer	R7 R8	569-25PR-1k
6	1N4002 diode	D1 D2 D3 D4 D5 D6	583-1N4002
2	LED, miniature red	LD1 LD2	351-3102
1	LM317T positive voltage regulator	U2	511-LM317T
1	LM337T negative voltage regulator	U1	511-LM337SP

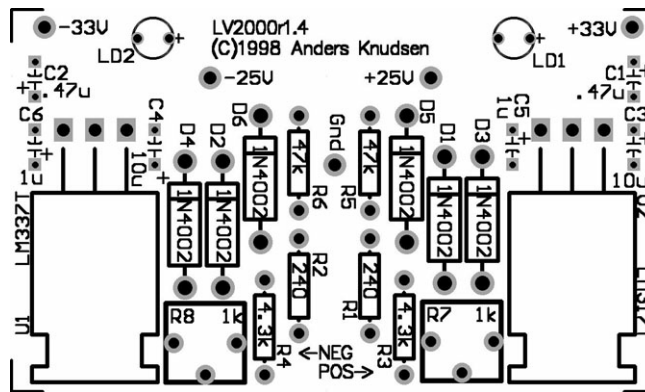

LV2000 PCB Silkscreen

To keep the components flush against the board when soldering, start with the lower profile components.

Place and solder the 6 resistors

(band colors are included for anybody that might be resistor color code challenged)

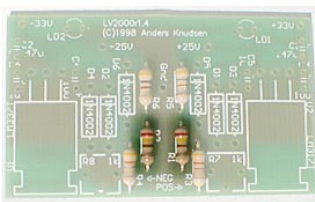

R1 & R2 – 240 ohm
(Red/Yellow/Brown)

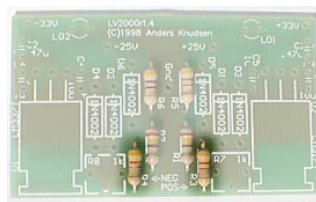

R3 & R4 – 4.3k
(Yellow/Orange/Red)

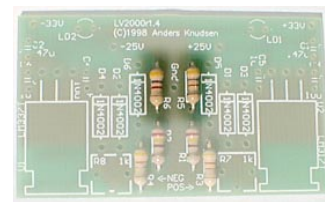

R5 & R6 – 4.7k
(Yellow/Purple/Red)

Place and solder the 6 Diodes

These go into locations D1-D6, all 6 diodes are oriented in the same direction with the stripe towards the top (the orientation of the diodes is also marked on the board). Keep at least 3 trimmed leads from the diodes; used later to make the standoffs.

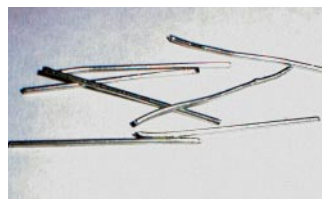
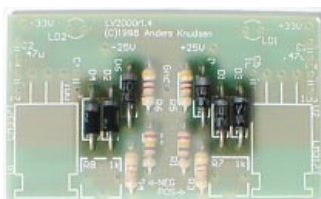

Place and solder the negative and the positive voltage regulator

BE CAREFUL THAT YOU DON'T SWAP THE REGULATORS!

The 337 (U1) is the negative (left side) and the 317 (U2) is the positive (right side).

Bend the leads before inserting them into the PCB, this will help them lay flush against the PCB.



Legs bent on regulators

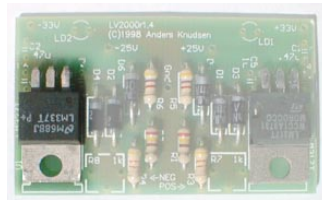

LM337T (-)

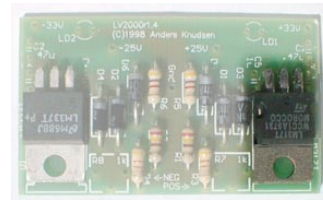

LM317T (+)

Place and solder the two potentiometers

The pots R7 and R8 will only fit in one way.



Place and solder capacitors

These components are NOT symmetrical on the board, and they are polarized.

(NOTE: the positive lead on the cap is the longest)

All the capacitors on the left (negative) side of the board are inserted with the negative lead towards the top.

The caps on the right (positive) side have the positive lead towards the top.

Also note that each of the 10uF caps (biggest caps) are placed on the right side of their respective voltage regulator and the 1uF caps (smaller) are on the left side of each of the voltage regulators.

A quick and easy check to verify that the caps are inserted in the correct direction is to look at the labels on the caps. The caps included in the kit have the + lead on the right when looking at the label. If your caps are this way, then all the labels on the caps face out from the center.



.47µF



1µF

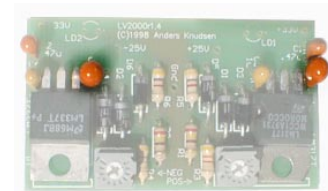

10µF

Place and solder the LEDs



For both LEDs the positive lead is placed to the right.

(NOTE: the positive lead is the longest)

You are now ready to install the stand-offs and the wires. See the Installation Instructions for details.